

SERIES FB

Door, Wall & Partition
Mounting
Intumescent
Fire Dampers

PUBLICATION

DAMPERS 8

MAY 2005

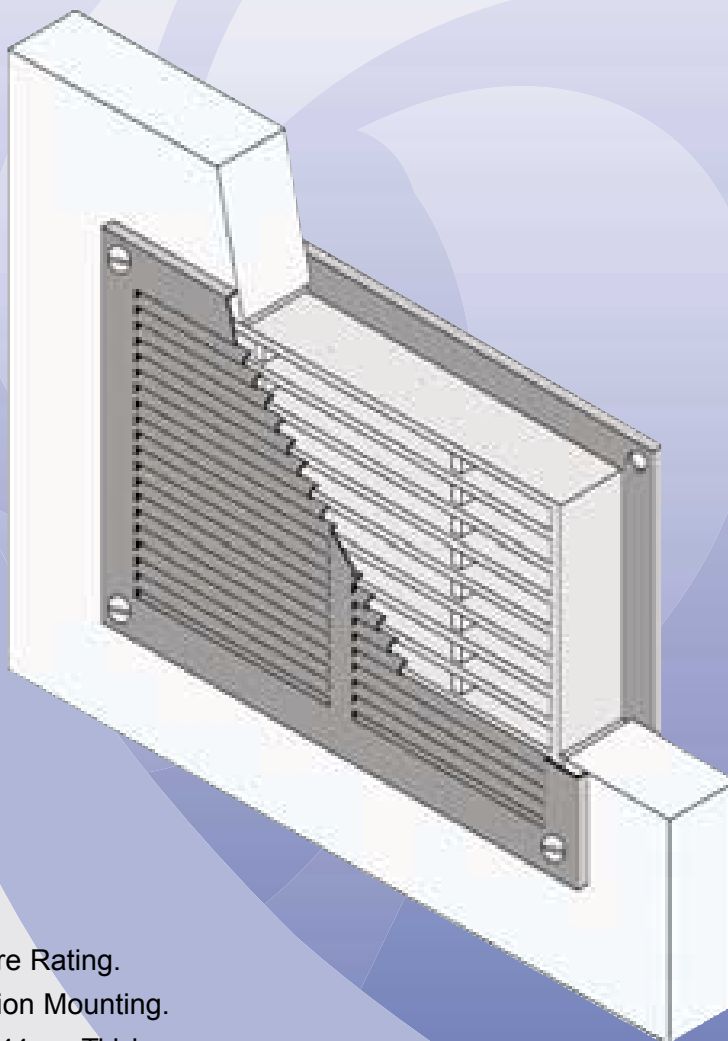

Features

- 60 or 120 Minute Fire Rating.
- Door, Wall or Partition Mounting.
- Narrow 40mm and 44mm Thickness.
- 60% Free Area.
- Fast Temperature Reaction.
- Fully Tested to BS 476 Part 20 1987.



GILBERTS

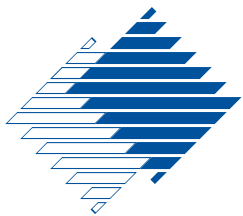

SERIES FB

Introduction

Gilberts FB Series provides a compact, efficient range of intumescent fire dampers designed to satisfy all types of air transfer application in offices, shops, schools, hospitals and many other commercial projects. Suitable for use in doors, walls or partitions the dampers are fabricated from thin intumescent slats which, under normal circumstances allow air to pass smoothly and freely however, in the event of a fire, they expand to many times their original thickness fusing to form a complete barrier to smoke and flames. With the added benefit of a PVC coating the dampers provide trouble free operation with low maintenance and no periodic testing requirements.

The FBL60 units have a full 1hr fire rating and are suitable for doors, walls and partitions. The FBL120, with its steel casing and steel slats (with intumescent core) has a higher 2 hr fire rating and is better suited to ducting applications or more aggressive environments. The FBC60 is a circular 1 hr rated unit particularly suited to PVC ducting. All units have been independently tested to BS476 Pt20 1987.

Available sizes range from 100mm sq up to 2400 x 1200mm and 100-600mm dia.

Matching fascia/cover grilles are available with the FB700 Series air transfer grille (see separate data sheet).

DIMENSIONAL DETAILS

TYPE FBL60 & FBL120

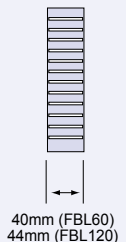
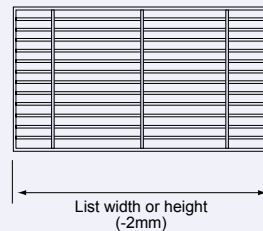
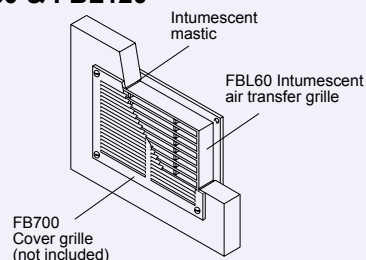

TYPE FBC60

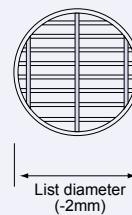
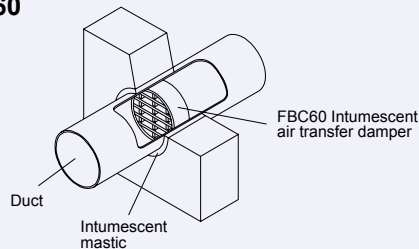

FREE AREA - (all units) Approx 60%

Ordering Specification

SERIES FBL60, FBL120, FBC60	FBL60	300 x 300	6
LIST SIZE (Width x Height or Dia mm)			
NUMBER REQUIRED			

(To order fascia grilles please see FB700 Series data sheet)

FIXING

Screw through frame into surrounding timber or duct and seal with intumescent paste.

SIZE RANGE

FBL60 & FBC60: 100 to 600mm Sq/Dia in 25mm increments.
 FBL120: 100 x 100 to 2400 x 1200 in 25mm increments. (Units 800mm and over supplied in modules)

Contact

GILBERTS

Head Office and Works
GILBERTS (BLACKPOOL) LTD
 Gilair Works, Clifton Road,
 Blackpool.
 Lancashire FY4 4QT.
 Telephone: (01253) 766911
 Fax: (01253) 767941
 e-mail: sales@gilbertsblackpool.com
 Web: www.gilbertsblackpool.com

